

ZIPSTOP ZIP LINE BRAKE

Operation and Maintenance Manual

Models: ZS125-08 / ZSIR150-20A / ZSSD150-20A



NOTE TO OPERATORS

Always Read Instructions Before Use

The Operation and Maintenance manual contains information relating to the proper operation, inspection and maintenance of the zipSTOP and includes all product registration and warranty information. Participant safety is dependent on actions of the operator(s). This document must be supplied to the owner after installation. Ensure that this manual is readily available to the Responsible Parties at all times.

Head Rush Technologies Manual - zipSTOP Operation and Maintenance Manual
P/N 13829-04

Head Rush Technologies products are covered by a number of patents, including **U.S. Patents** 8,490,751; 8,851,235; 9,016,435; and D654,412 & corresponding patents/applications in the USA and in other countries worldwide.



zip STOP™

ZIP LINE BRAKE

SPEED



CAUTION

Read and adhere to all product labels, front & reverse of device and Operator Instructions. Inspect device before each use. Failure to adhere to these instructions may result in serious or fatal injury.

head rush
technologies
www.headrushtech.com

U.S. Patents 8,699,744, 8,693,246, 8,693,435 and 8,694,402 & corresponding foreign jurisdictions in the USA and/or other countries worldwide.

LABEL P/N: 18332-02



TABLE OF CONTENTS

SAFETY INFORMATION	4
Safety Warnings	4
Symbols Used in this Manual	6
Safety Information	6
Emergency Arrest Device (EAD) Confirmation	7
Regulations and Standards	7
Warranty	7
INTRODUCTION	8
How the zipSTOP Zip Line Brake Works	8
Models, Specifications, and Parts: zipSTOP and Brake Trolley	9
zipSTOP Operation and Maintenance Manual	11
ZIPSTOP OPERATION	12
Redirection/Reduction System Components	12
Operational Envelope	13
Facility Operational and Training Procedure	13
Operating Procedure	13
INSPECTION AND MAINTENANCE	15
Daily Inspection	15
Weekly Inspection	16
Bi-Annual Inspection	16
Recertification	16
Re-Commissioning Testing	17
Webbing Inspection	17
Webbing Replacement	21
Nozzle Assembly Replacement	22
Side Cover Replacement	23
bumpSTOP Replacement	23
Long Term Storage	24
IMPROPER OPERATION	25
MANUFACTURER'S DETAILS	26

SAFETY INFORMATION

Safety Warnings

READ BEFORE INSTALLATION & OPERATION

WARNING



DO NOT USE OR INSTALL A ZIPSTOP UNLESS AN EMERGENCY ARREST DEVICE (EAD) THAT PREVENTS SERIOUS INJURY* OR DEATH, MAKES THE BRAKING SYSTEM FAIL-SAFE, AND MEETS THE REQUIREMENTS SPECIFIED IN THIS MANUAL IS PRESENT

All Requirements and Instructions Must be Followed to Achieve Proper Operation and Participant Safety

DO NOT USE A ZIPSTOP UNLESS ALL INSTRUCTIONS AND REQUIREMENTS ARE SATISFIED

Prior to installation and operation, all Responsible Parties must have read and shown to have understood all requirements, instructions, labels, markings and safety information pertaining to the correct installation, operations, inspection and maintenance of the zipSTOP brake, its component parts and all associated hardware and systems. Failure to do so may result in equipment damage, serious injury or death.

*Serious injury includes any of the following injuries: fractures, amputations / dismemberment, permanent loss of the use of a body organ / member / function / system, injury likely to lead to permanent loss or reduction of sight, any crush injury to the head or torso causing damage to the brain or internal organs, serious burns, any scalping, any loss of consciousness caused by head injury or asphyxia, significant disfigurement, loss of a fetus, or other significant injury / illness that requires immediate admission and overnight hospitalization and observation by a licensed health care professional.

Serious injury is also commonly determined by the Authority Having Jurisdiction, the more conservative definition applies.

Definition from EN15567 and ASTM F2959

WARNING



The following items are critical and must be understood by all persons involved with the installation, operation, and service of a zip line utilizing a zipSTOP. This includes, but is not limited to: all Responsible Parties, guides / operators, owners, service technicians, designers, installers, etc.

- **Emergency Arrest Device** – a suitable Emergency Arrest Device (EAD) that meets the requirements specified in this manual must be used at all times.
- **Arrival Speed** – the device / configuration arrival speed limits must NEVER be exceeded.
- **Qualified Person(s)** - The installation and commissioning of a zipSTOP equipped braking system must be completed by a qualified person(s). Head Rush Technologies is not a zip line brake system designer or installer and therefore cannot approve zip line braking systems.
- **Minimum Requirements** – All minimum requirements in this manual must be satisfied
 - Redirection Rope – redirection systems require the use of Gorilla Rope or direct equivalent.
 - Compatible Components – all components used must be compatible with the system, including: redirection pulley, brake trolley, rider trolley, etc.
- **Inspection** – Prior to every descent, the redirection system and EAD must be inspected for readiness including proper reset and entanglement hazards.
- **Correct Installation and Operation** – This manual illustrates only some of the possible correct and incorrect methods of installation and operation. It is impossible to address every scenario and configuration relating to the use of this equipment. It is ultimately up to the qualified person(s) and Responsible Party to ensure safe and correct installation and operation.
- **Risk Assessment and Rescue** – A risk assessment including a ride and failure analysis must be conducted and corresponding rescue plan in place prior to the installation and use of the zipSTOP.

Symbols Used in this Manual

The following safety symbols are used throughout this manual to highlight potential danger to participants and equipment. One or more precautions may be associated with practices and procedures described within this manual. Failure to adhere to any precautions highlighted can result in equipment damage, serious injury or death.



Indicates a potentially hazardous situation exists that, if warnings are not observed, may result in improper operation, equipment damage, serious injury or death.



Indicates an action that must be taken to prevent improper operations, equipment damage, serious injury or death.



Indicates a scenario, configuration, action, etc. that is not allowed and may result in improper operation, equipment damage, serious injury or death.

Safety Information

The zipSTOP Brake assembly, including zipSTOP Brake Units Models zipSTOP ZS125-08, zipSTOP IR ZSIR150-20A and zipSTOP SPEED ZSSD150-20A, zipSTOP Brake Trolley ZT125-17 and all accessories are designed and specified for use in the recreational zip line industry as components within a braking system designed by a qualified person. Use of the zipSTOP device or accessories for any purposes other than that intended by the manufacturer is not permitted.

The zipSTOP is designed to be utilized as a Primary Brake or Emergency Arrest Device (EAD). When using the zipSTOP as a primary brake, the Responsible Parties MUST utilize an independent EAD to protect against operator error and equipment failure. When used as an EAD, the zipSTOP configuration must meet all Head Rush Technologies' and other applicable requirements. Design, installation, and qualification of the zip line ride, including the braking system, must be completed by a qualified person and is the responsibility of the installer, owner, engineer, designer or other Responsible Party.

Owners and Operators of zipSTOP devices are responsible for the safety and supervision of any person using the zip line and are required to undergo training the the correct operation, inspection and maintenance prior to any use. Designers, Installers and/or other Responsible Parties must assure that proper installation and operational training are documented and provided to the Owner / Operator. Proper installation requires careful design and planning using zipSTOP and non-zipSTOP components. Proper operational procedure is left up to the Responsible Party and must ensure compatibility with all hardware, systems, other ride requirements and procedures.

Responsible Parties are encouraged to seek the advice of a zip line installer, designer/engineer, or other qualified person regarding the instructions in this Manual. Head Rush Technologies is not a designer or installer and therefore cannot approve a zip line braking system.



THESE INSTRUCTIONS MUST BE MADE READILY AVAILABLE TO ALL RESPONSIBLE PARTIES AT ALL TIMES.

Emergency Arrest Device (EAD) Confirmation



THE EAD MUST PREVENT SERIOUS INJURY OR DEATH AND BE FAIL-SAFE. ZIP LINES USING THE ZIPSTOP BRAKE ARE REQUIRED TO USE INDEPENDENT PRIMARY AND EMERGENCY ARREST DEVICES TO ARREST THE MOTION OF RIDERS.

Use of an EAD that prevents serious injury and makes the braking system fail-safe is required. The EAD must automatically engage upon failure of the primary brake. An EAD cannot be dependent on a participant or guide to engage upon failure of the primary brake and cannot be tethered to or use the reset of the zipSTOP to reset the EAD.

Installation and use of a zipSTOP constitutes acknowledgement by the Responsible Party that the following requirements regarding use of an adequate EAD have been satisfied:

- The Installation and Operation and Maintenance Manuals have been understood by all Responsible Parties.
- An adequate EAD rated to the arrival speed and weight range which makes the braking system fail-safe is present, functional and inspected prior to every zip line descent.
- The EAD has been tested by a qualified person in accordance with this manual, ASTM F2959 and other requirements in accordance with the Authority Having Jurisdiction and has been shown to make the braking system fail-safe independent of the primary brake for all rider weights, speeds and orientations.

Regulations and Standards

The zipSTOP, zipSTOP IR and zipSTOP SPEED devices and supplied components comply with all applicable requirements of ASTM F2959-18 Standard Practice for Aerial Adventure Courses.

All zipSTOP Devices, Brake Trolley, and all Head Rush Technologies' accessories are designed for use as components within a zip line braking system. A zipSTOP device may be operated so long as a qualified person designs and installs a suitable braking system that meets or exceeds all requirements stated in this manual and any applicable requirements in accordance with the Authority Having Jurisdiction. Applicable standards may include, but are not limited to, Association for Challenge Course Technology (ACCT), EN 15567-1 Sports and Recreational Facilities – Ropes Courses, Professional Ropes Course Association (PRCA), ASTM F2959 Standard Practice for Aerial Adventure Courses, and ASTM F770 Standard Practice for Ownership and Operation of Amusement Rides and Devices.

Warranty

Manufacturers sole warranty. The zipSTOP Brake assembly will be sold free from defects in materials and workmanship, excluding field replaceable wear parts, for a period of one (1) year from date of purchase. This warranty only applies to the original purchaser, and is contingent upon the Responsible Parties using and maintaining the device in accordance with the zipSTOP instructions, including the requirement to maintain annual recertification as described in the Installation and Operation and Maintenance Manuals.

This warranty is expressly in lieu of other warranties, express or implied, and any implied warranty of merchantability or fitness for a particular purpose is hereby expressly excluded. The sole remedy for breach of said warranty or for any claim in negligence or strict liability in tort is the repair or replacement of any defective parts at the discretion of the manufacturer. Such parts claimed to be defective shall be returned to the Head Rush Technologies Service Center, transportation prepaid, for inspection by an authorized Head Rush service technician to determine to its satisfaction that said part(s) are defective.

This warranty is null and void if other than genuine parts are used, if any modifications are carried out to the zipSTOP Brake assembly or zipSTOP components without the expressed written permission of the manufacturer, such as if used outside of intended application or beyond the stated device weight and speed limits.

No person, Agent or Distributor is authorized to give any warranty, other than the one herein expressed, on behalf of the Company or to assume for it any liability pertaining to such products. The company makes no warranties in respect to trade accessories or component parts which are not manufactured by the company, same being subject only to such warranties, if any, as may be made by their respective manufacturers.

INTRODUCTION

How the zipSTOP Zip Line Brake Works

The zipSTOP Zip Line Brake is a patented self-regulating eddy current braking device designed to be used as a component within the braking system at the terminal end of a zip line. The zipSTOP has a self-regulating brake design and can accommodate a range of rider weights and arrival speeds without external input. The zipSTOP is connected to a brake trolley at the terminal end of the zip line; when the arriving rider contacts the brake trolley the webbing is pulled out from the zipSTOP which transmits braking force to the rider. The extension of the webbing spins a conductive rotor within a counter-rotating magnetic field. The relative motion between the rotor and magnetic field creates a magnetic drag force, called eddy current braking (ECB), due to electromagnetic induction, providing a braking force to the webbing and brake trolley gently stopping the rider. After the rider dismounts, a spring within the zipSTOP automatically retracts the webbing and resets the brake trolley so it is ready for the next rider.

Every zip line is different and every braking system must be designed to satisfy specific requirements. Three different zipSTOP models are available which may be configured in different ways to accommodate a range of arrival speeds, weights and site specific conditions. The Responsible Parties must ensure the finalized braking system is satisfactory for the allowable operational range, meets the needs of the system and applicable standards. Unmanned testing and qualification is required with all installations. The intention of this manual is to provide guidance on standard practices and common configurations; it is not intended to address every possible configuration or scenario. It is ultimately up to the Responsible Parties to ensure the complete braking system is adequate and compatible with the requirements and needs of the zip line.

Additional information regarding the installation and use of zipSTOPs, EADs, accessories, inspection, maintenance and many other topics may be found at www.headrushtech.com.



THE FIGURES PRESENTED IN THIS MANUAL ARE NOT TO SCALE AND MAY NOT SHOW ALL REQUIRED COMPONENTS OR STRUCTURES, INCLUDING, BUT NOT LIMITED TO: EAD, ANCHORS, GUY LINES, SAFETY EQUIPMENT, ETC.



IT IS UP TO THE RESPONSIBLE PARTY TO ENSURE THAT THE BRAKING SYSTEM INCLUDES ALL NECESSARY EQUIPMENT, IS APPROPRIATELY DESIGNED AND FUNCTIONAL FOR THE LIFE OF THE ZIPLINE. THIS MAY INCLUDE PERIODIC INSPECTION, MAINTENANCE AND REPLACEMENT OF COMPONENTS.



THIS MANUAL IS FOR OPERATION AND MAINTENACE ONLY. ZIPSTOP DEVICES MUST BE INSTALLED BY A QUALIFIED PERSON.

Models, Specifications, and Parts: zipSTOP and Brake Trolley

Three models of zipSTOP are available to accommodate a range of arrival speeds. Every zipSTOP comes with a brake trolley and mounting bracket for anchoring the zipSTOP. The owner should keep the original packaging to use for storage and shipping of the device.

All zipSTOP Models

OPERATING TEMPERATURE	-4°C (25°F) to 60°C (140°F)
OPERATING TEMPERATURE DRY	-10°C (14°F) to 60°C (140°F)
STORAGE TEMPERATURE	-20°C (-4°F) to 60°C (140°F)
WEIGHT RANGE	15 to 150 kg (33 – 330 lbs)

zipSTOP Brake Unit, ZS125-08

MAXIMUM WEBBING EXTENSION	12.5 m (41 ft)	
MAXIMUM ARRIVAL SPEED	1:1 Redirection Ratio	36 km/h (22 mph)
	2:1 Redirection Ratio	60 km/h (37 mph)

zipSTOP IR Brake Unit, ZSIR150-20A

MAXIMUM WEBBING EXTENSION	20 m (65 ft)	
MAXIMUM ARRIVAL SPEED*	1:1 Redirection Ratio	60 km/h (37 mph)

* Only 1:1 Redirection Ratio Allowed

zipSTOP SPEED Brake Unit, ZSSD150-20A

MAXIMUM WEBBING EXTENSION	20 m (65 ft)	
MAXIMUM ARRIVAL SPEED**	2:1 Redirection Ratio	72 km/h (45 mph)

** Only 2:1 Reduction Ratio Allowed

NOTE: All Reduction Ratios must be configured properly for reliable, automatic reset. Operating without reliable, automatic reset is not allowed.

NOTE: Maximum webbing extension is not the braking distance, but refers to the amount of webbing in the device. Refer to the braking distance charts to see Braking Line Extension.

zipSTOP Brake Trolley

ZT 125-17-1/2	For use with 1/2 inch [12-13mm] zip lines
ZT 125-17-5/8	For use with 5/8 inch [16mm] zip lines
ZT 125-17-3/4	For use with 3/4 inch [19mm] zip lines

The following nomenclature and components are referenced throughout the Installation and Operation and Maintenance Manuals.

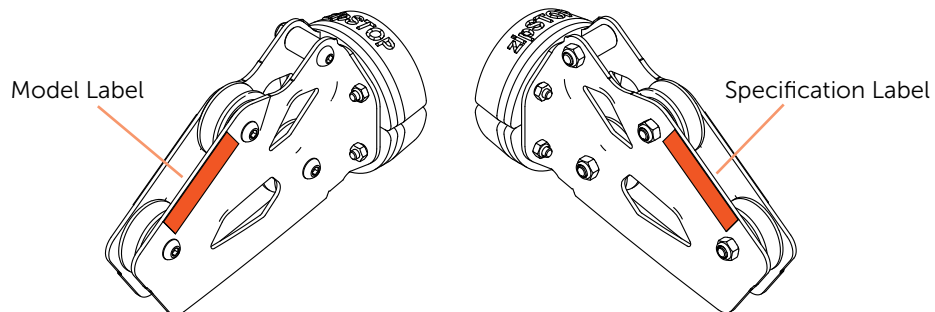
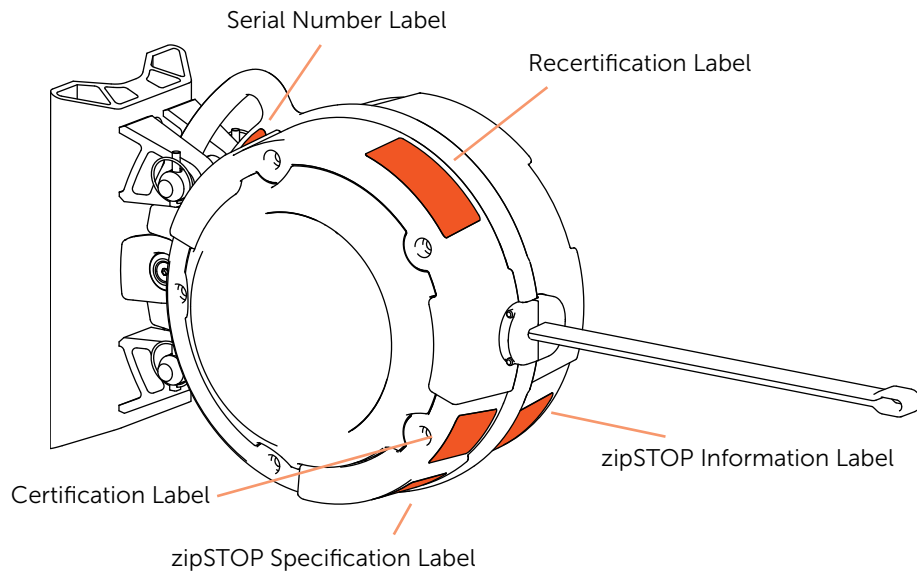
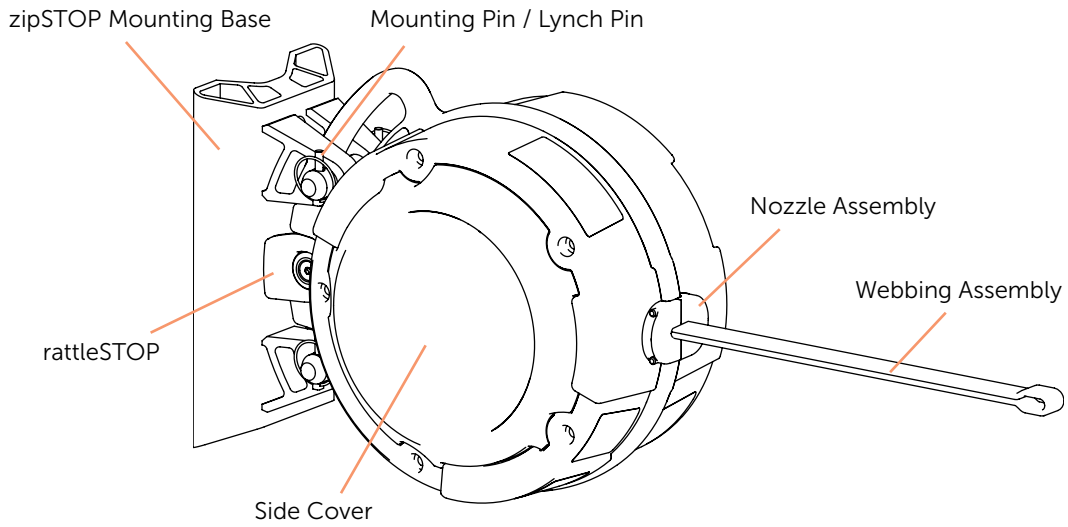

zipSTOP Operation and Maintenance Manual

This Operation and Maintenance Manual includes instructions for all Responsible Parties who will be operating the zipSTOP or otherwise assisting a rider's zip line ride which uses a zipSTOP. This is predominately facility "guides" but also owners, service technicians, builders/installers conducting tests, inspectors, etc. A separate zipSTOP Installation Manual (PN 11911) is also supplied with each device and addresses the installation, testing, commissioning, etc. associated with using a zipSTOP within a braking system. The Installation Manual provides further understanding of how a zipSTOP operates, what associated components may be required and what factors influence performance.

This manual addresses the basic principles of zipSTOP operation but does not cover site specific operational procedures including, but not limited to: participant anchoring, safety at height, connection to and dismount from the zip line, additional equipment such as rider trolleys, harnesses, helmets, or emergency and site rescue plans. This manual addresses proper operation, inspection, and maintenance of the zipSTOP device only.



ADDITIONAL PROCEDURES ARE REQUIRED FOR PARTICIPANT SAFETY AND PROPER OPERATION OF THE ZIP LINE AND BRAKING SYSTEM. THE INSTRUCTIONS IN THE MANUAL ADDRESS ZIPSTOP OPERATION ONLY.

ZIPSTOP OPERATION

Redirection/Reduction System Components

The below diagrams illustrate the typical components within a typical zipSTOP line braking system. Depending on the installation, additional or fewer components may be required.

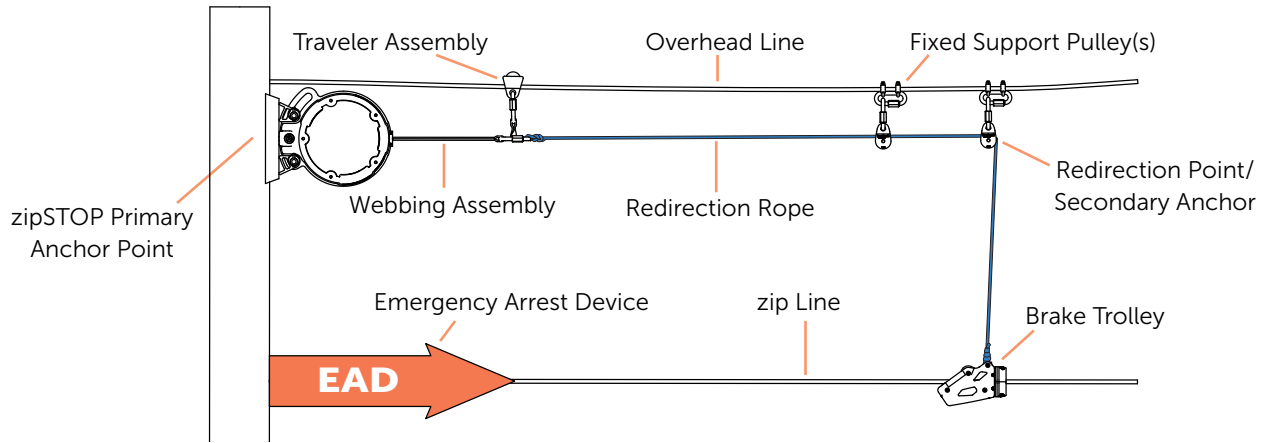

Redirection System Components

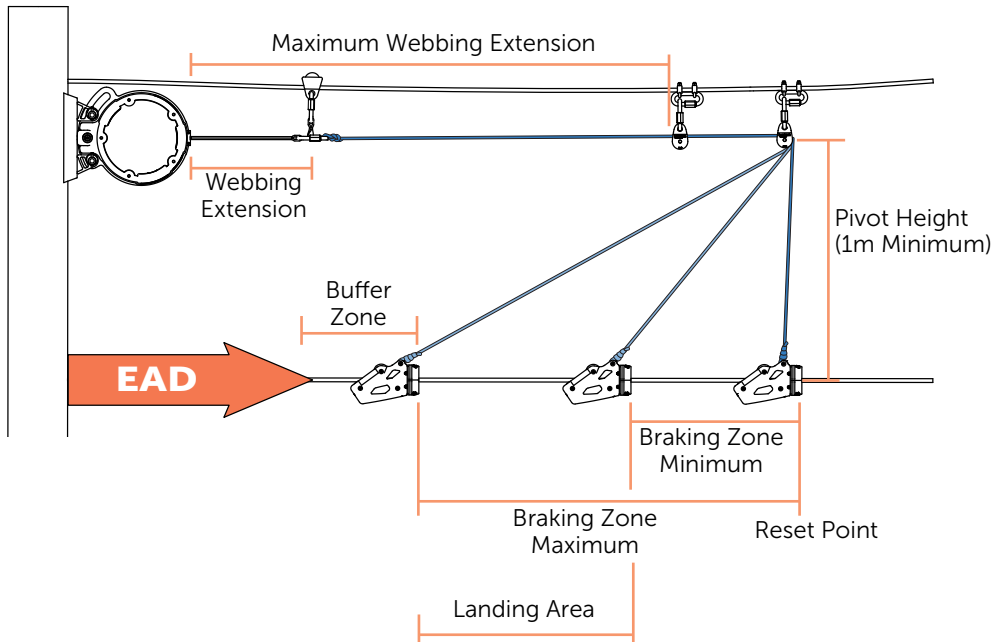

Braking Zone Dimensions

Operational Envelope

Prior to operation, every zipSTOP braking system must be tested and an operational envelope established by the Responsible Party in accordance with the zipSTOP Installation Manual. The operating envelope is the set of limits and conditions which zip line operations must stay within to ensure proper operation of the zip line and braking systems, particularly arrival speed.



THE DOCUMENTED OPERATING PROCEDURE MUST INCLUDE PROVISIONS AND PROCEDURES TO PREVENT OPERATION OUTSIDE THE OPERATIONAL ENVELOPE, ACCOUNTING FOR: WIND SPEED / DIRECTION, WEIGHT, RIDER POSITION, ETC.



THE MAXIMUM ARRIVAL SPEED MUST NEVER BE EXCEEDED FOR THE PRIMARY BRAKING SYSTEM AND EAD IN ANY CONDITION.

Facility Operational and Training Procedure

Facilities utilizing a zipSTOP must have and follow a documented operational and training procedure which addresses all necessary tasks for proper operation, maintenance, inspection, safety, rescue etc. This document must take into account all items within this manual as well as any item pertaining to site specific requirements, safety and rescue. Association for Challenge Course Technology (ACCT) guidelines, Professional Ropes Course Association (PRCA) guidelines or ASTM F770: Standard Practice for Ownership, Operation, Maintenance, and Inspection of Amusement Rides and Devices, etc. may be utilized as a reference. It is up to the Responsible Parties to generate this procedure, perform training, and ensure efficacy and adherence.

Operating Procedure



PRIOR TO DAILY OPERATIONS, THE ZIPSTOP DEVICE AND ASSOCIATED COMPONENTS MUST BE INSPECTED AND DOCUMENTED IN ACCORDANCE WITH SECTION: *DAILY INSPECTION*.



THE FOLLOWING INSPECTION AND OPERATIONAL PROCEDURE FOR OPERATION OF A ZIPSTOP ONLY. THE ZIP LINE OPERATIONAL AND TRAINING PROCEDURE MUST INCLUDE THESE ITEMS IN ADDITION TO ALL OTHER SAFETY AND SITE SPECIFIC REQUIREMENTS.

1. Inspect proper reset and braking system readiness
 - a. EAD is ready, operational and correctly located.
 - b. There are no participants or obstacles on the zip line which may interfere with an arriving rider or any part of the braking system.
 - c. Webbing is properly retracted into the zipSTOP.
 - d. Brake trolley is in the reset position and correctly oriented.
 - e. The redirection system / components are not twisted, entangled, and are running free and clear.
 - f. Operational / environmental conditions, particularly wind direction and speed, are within the operational envelope.
2. Rider Attachment and Descent
 - a. Prior to rider descent, procedures must be in place to ensure system readiness, correct operational procedures are followed and communicate zip line status between the launch and arrival areas. This may include guide verbal or visual communication, safety related control systems (SRCS), etc.

- b. Riders must descend one at a time.
3. Rider Braking
 - a. zipSTOP braking mechanism engages and self-regulates without external input from rider or guide.
 - b. Avoid contact and pinch hazard between the rider and moving objects including rider trolley, brake trolley, redirection system and/or other components. Rider swing up during braking must be accommodated.
4. Rider Recovery / Dismount
 - a. After rider has reached a full stop, guide may facilitate rider recovery and dismount.
5. System reset
 - a. After rider dismount, brake trolley and braking system shall be allowed to reset automatically.



OPERATORS MUST BE AWARE OF AND TAKE THE FOLLOW PRECAUTIONS AT ALL TIMES IN ADDITION TO THE OPERATING PROCEDURE.



ALL DEFICIENCIES MUST BE CORRECTED PRIOR TO RIDER DESCENT.

- Ensure reliable reset after every descent
 - The braking system must be designed such that reliable reset is achieved after every use. Operation without reliable reset is not allowed. Failure of the zipSTOP to reset the brake trolley will result in no braking from the zipSTOP, inadequate braking, abrupt braking, etc.
- Redirection ropes can become twisted, entangled or rub on an overhead cable, the main zip line cable, other structures or components.
 - Damage to redirection ropes, webbing or other textiles will occur if it contacts other components under load or motion. Inspection for damage **MUST** occur at least daily and as required.
 - Ropes becoming entangled with a participant present a dangerous scenario; provisions must be present to prevent rider entanglement.
 - Separation of the redirection rope or zipSTOP webbing will disconnect the rider from the braking system resulting in no braking from the zipSTOP. An adequate EAD must be capable of arresting a rider in all conditions in this event.
- Avoid rider contact with any zip line or braking components.
 - Serious injury may result if the rider contacts the trolley or other components when it impacts the brake trolley. Design or operational procedures must be in place to prevent the rider from contacting or having any part of their body caught between the rider trolley and brake trolley.
 - Non-forward facing arrival may result in riders' heads being in closer proximity to the zip line. Serious injury due to upswing may result if rider is not in the forward-facing position. When the possibility of non-forward-facing arrival exists, ensure riders cannot come into contact with the zip line, brake trolley or other objects during deceleration.
- Never exceed device weight or speed limits.
 - Exceeding device limits may cause improper operation, webbing damage, and/or internal device damage which cannot be visually inspected. If this occurs the zipSTOP will need to be sent to an Authorized Service Agent for inspection and repair.

INSPECTION AND MAINTENANCE



ALL ZIPSTOP DEVICES MUST BE INSPECTED AND MAINTAINED IN ACCORDANCE WITH THIS MANUAL. RECORDS OF INSPECTION, SERVICE, COMPONENT REPLACEMENT AND OTHER MAINTENANCE MUST BE KEPT.

Always use genuine Head Rush replacement parts; any modifications without the expressed written consent of Head Rush Technologies is not allowed. Third party components shall be inspected and serviced in accordance with that manufacturer's instructions. Supplemental instructions, demonstration videos and inspection logs are available at headrushtech.com.

Daily Inspection

Prior to daily operations, the zipSTOP device and associated components must be inspected. Inspection of the zipSTOP includes, at minimum, the below items. Additional structures, systems and equipment shall be inspected in accordance with the facility's documented procedure, manufacturers' instructions and/or other instructions from the Responsible Party.

1. **Device Condition** – Visually inspect the exterior of the zipSTOP device for damage, corrosion, loose fittings and fasteners.
2. **Device Mount** – Inspect the zipSTOP Brake Unit mounting bracket and pins for damage and ensure device and mount are suitably secured.
3. **Webbing Assembly** – Fully extend the Braking Line from the zipSTOP Brake Unit. Check the line condition for damage or discoloration, refer to Section: **Webbing Inspection**. If worn or damaged, replace with a new webbing assembly.
4. **Webbing Extension and Retraction** – Check that the webbing extension and retraction is smooth, maintains resistance throughout its range and the webbing is properly retracted.
5. **Brake Trolley Bumper** – Check that the Brake Trolley bumpSTOPS are secure and free from damage or excessive wear that will hinder performance.
6. **Brake Trolley Operation** – Check the Brake Trolley is free from damage and operates smoothly throughout its operating range and that it correctly resets to the reset point.
7. **Redirection Rope and Pulleys** – Inspect the redirection rope and pulleys to ensure the rope runs free and clear without entanglement or abrasion. Inspect overall condition of entire line, terminations and ensure it is in operable condition. Replace if necessary.
8. **Connecting Hardware** – Check that all connecting and additional hardware is in operational condition, secure and free of corrosion.
9. **Traveler Assembly** – Inspect that all hardware is secure and free from damage. Check that the assembly runs free and clear.
10. **EAD** – Inspect EAD condition and operation per manufacturer's instructions.

Weekly Inspection

Once weekly, the condition of the device casing and side covers shall be visually inspected for damage or corrosion. If operating in a salty or harsh environment, remove the side covers and visually inspect the internal components for corrosion. If red rust is found, the device must be immediately taken out of service and returned for recertification. White scaling is acceptable and does not require a recertification. Reinstall the side covers after inspection.

Bi-Annual Inspection

Once every 6 months, the condition of the internal drum lead, shackle/shackle pin and nozzle assembly shall be visually inspected for wear and damage. Inspect the drum lead and webbing assembly termination for damage, refer to Section: **Webbing Inspection**. Inspect the shackle and shackle pin for damage or deformation. Unless replacing the webbing, do not loosen or tighten the shackle pin as this will break the thread locking compound. Inspect the nozzle assembly for damage and wear of the stainless steel insert.

Recertification

The zipSTOP Brake Unit requires an annual service and recertification to be carried out by an Authorized Headrush Service Agent. The zipSTOP should be packaged in its original protective foam and box in order to safeguard the device from damage during shipping.

The recertification expiration date is shown on the recertification label located on the device casing. Dismount the zipSTOP device and return to an Authorized Service Center prior to the Next Recertification Date shown. To dismount, follow instructions provided in the zipSTOP Installation Manual and/or instructions provided by the Responsible Party. Document the orientation and connection details prior to dismounting device to aid reinstallation.

head rush
technologies

SERIAL NUMBER:

MANUFACTURE DATE: / /

RECERTIFICATION DATE: / /

NEXT RECERT REQUIRED: / /

BY:

10024-01

"Next Recert Required" Date Shown Here



DO NOT OPERATE AFTER THE NEXT RECERTIFICATION DATE ON THE RECERTIFICATION LABEL.

Re-Commissioning Testing

Because many elements can change over time, it is a requirement that periodic testing be performed of the zip lines and braking system to verify original performance. Testing shall be conducted annually and upon any modification that may affect zip line or braking system performance. Periodic load testing and monitoring is the only way to ensure that arrival speeds remain as designed and stay within established limits. Refer to the zipSTOP Installation Manual and/or documents from the Responsible Parties for additional information, procedures, and requirements.



RE-COMMISSIONING TESTING IS REQUIRED ANNUALLY AND UPON ANY MODIFICATIONS THAT MAY AFFECT ZIP LINE OR BRAKING SYSTEM PERFORMANCE. CONSULT WITH YOUR BUILDER AND THE INSTALLATION GUIDE PROVIDED WITH THE ZIPSTOP. REPLACEMENT MANUALS CAN BE DOWNLOADED FROM HEADRUSHTECHNOLOGIES.COM

Webbing Inspection



INSPECT THE WEBBING ASSEMBLY DAILY IN ACCORDANCE WITH THE FOLLOWING INSTRUCTIONS. USING THE DEVICE WITH UNACCEPTABLE WEAR OR DAMAGE IS PROHIBITED.











The webbing assembly is a wear component which requires daily inspection and periodic replacement when it shows signs of wear, damage or contamination. More frequent inspection may be required for high throughput facilities or when operating in harsh environments. Refer to Wear Tables, below, for examples of acceptable and unacceptable wear. These tables do not include all possible types of wear or damage, if in doubt remove webbing from service. Webbing must be removed from service if it does not pass inspection. Refer to the Webbing Wear Troubleshooting Chart for possible causes of accelerated webbing wear. Continued use of webbing beyond stated limits may result in separation, disconnecting the rider from the braking system.

To inspect the webbing, extract the entire length from the device and carefully examine both edges and faces for wear or damage including:

- Damage to stitching
- Cuts to the face or edges
- UV degradation including discoloration, fading, brittleness or chalking
- Hard fibers
- Surface glazing or melting appearance
- Permanent deformation or warping
- Contamination from chemicals, dirt, grit, sand, dust, etc.

WEAR TABLES

Webbing pictures outlined in **red** in the tables below show webbing that **MUST** be taken out of service and replaced immediately to continue using your zipSTOP. The **green** outlined photos show webbing that can be kept in operation.









zipSTOP		
Degree of Wear	Side Wear	Face Wear
NEW		
STAGE 1		
STAGE 2		
STAGE 3		
STAGE 4		

zipSTOP Webbing Wear Table

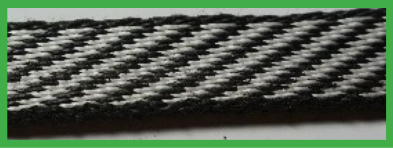
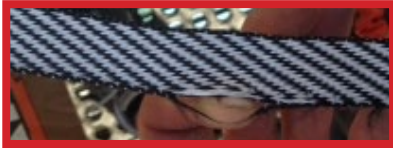
WEAR TABLES

Webbing pictures outlined in **red** in the tables below show webbing that **MUST** be taken out of service and replaced immediately to continue using your zipSTOP. The **green** outlined photos show webbing that can be kept in operation.

zipSTOP IR/ zipSTOP SPEED

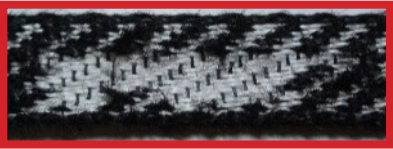
Degree of Wear	Side Wear	Face Wear
NEW		
STAGE 1		
STAGE 2		
STAGE 3		
STAGE 4		
STAGE 5		

zipSTOP IR / zipSTOP SPEED Webbing Wear Table

Symptom	Potential Cause	Potential Solution
Webbing face or side wear	Normal wear and tear	Replace with genuine Head Rush Technologies webbing assembly
	Webbing not extracted straight from nozzle	Ensure zipSTOP is mounted correctly and the webbing is coming straight out of the nozzle. Refer to Installation Manual for correct configuration.
	Webbing is rubbing on obstruction.	Check that the webbing is running free and clear of all structures, objects, etc.
	Nozzle is damaged.	Inspect nozzle and stainless steel insert for wear, burrs or other damage. Nozzle is a wear item, replace if necessary.
	Foreign objects including dirt, sand, debris, etc. have contaminated webbing and/or device.	Cover the zipSTOP when not in use. Wipe webbing clean with a dry cloth daily.
Bar tack damage	Fast retraction, impact with nozzle	Adjust redirection rope so webbing does not run into nozzle.
Sudden webbing wear, particularly side separation/stringing	Device has experienced over-speed (arrival faster than device/configuration maximum).	Cease operations immediately. Unit will require internal inspection and service by Authorized Service Agent.
Webbing shows mold, mildew	Webbing stored or not being dried after use in wet conditions	Whenever the zipSTOP will not be used or will be stored for an extended period after use in wet conditions, fully extend webbing and allow to dry in clean, dry environment out of the sun. Do NOT use heat to dry webbing.
Webbing is faded or discolored	Webbing has been subjected to high UV exposure or chemicals.	Ensure webbing is fully retracted into device when not in use, avoid chemical exposure.

Webbing Wear Troubleshooting Chart

Webbing Replacement

Replacement of the webbing assembly may be carried out with the zipSTOP in place or removed and secured to a workbench.

To replace the webbing assembly:

1. Disconnect the redirection system from the end of the zipSTOP webbing
2. Remove the nozzle assembly
3. Extract the entire length of webbing including the drum lead
4. Use a suitable holding pin through the loop in the drum lead above the shackle, Figure 6. This will prevent the line from retracting back into the device.



IF THE DRUM LEAD RETRACTS BACK INTO THE DEVICE THE DEVICE WILL REQUIRE SERVICE BY AN AUTHORIZED SERVICE AGENT, DO NOT USE.

5. Unscrew the shackle pin and remove webbing assembly. Discard the old shackle pin. Cut off ends of used webbing before discarding to ensure it is not accidentally re-used.



ALWAYS USE A NEW SHACKLE PIN PROVIDED WITH THE WEBBING REPLACEMENT. NEW SHACKLE PINS COME WITH SINGLE USE ONLY THREAD LOCKING COMPOUND.

6. Install the new webbing assembly and shackle pin ensuring the shackle loop is fitted to the drum lead and shackle pin to the end of the webbing. Ensure that the new webbing assembly is correct for the device model.
7. Tighten the shackle pin until fully seated
8. Remove the holding pin and allow the line to slowly retract without twisting until the drum lead and sewn webbing end are inside the device
9. Replace the nozzle assembly
10. Allow the webbing to slowly retract into the device without twisting while maintaining constant tension. Ensure the retraction force is smooth and adequate resistance is felt.
11. Once the line is fully retracted, pull the line out a short distance (~1m) and allow it to retract. Repeat two or three times to ensure the line is firmly wound onto the drum.
12. If necessary, reinstall the zipSTOP and reconnect the redirection system.

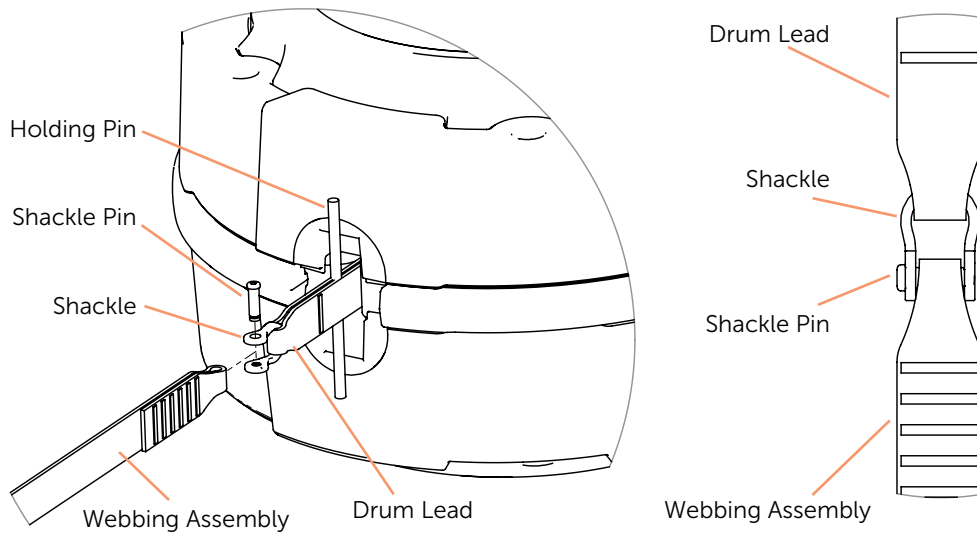

Webbing - Drum Lead Connection

Nozzle Assembly Replacement

The nozzle assembly is located on the zipSTOP Brake Unit casing and provides guidance for the webbing during extraction/retraction. The nozzle assembly is a wear component and will need to be inspected regularly; replacement is on a conditional basis. Service of the nozzle assembly may be carried out with the zipSTOP in place or removed and secured to a workbench.

To remove the nozzle assembly:

1. Secure or hold the webbing to prevent it retracting into the device when the nozzle is removed.
2. Extract the U-shaped nozzle pin using a flat head screwdriver or comparable tool
3. Remove the two nozzle halves

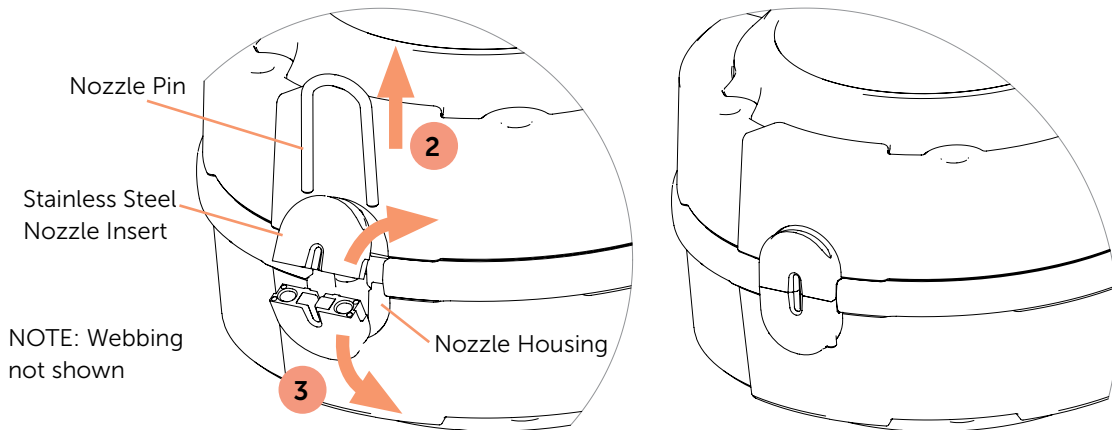

Nozzle Assembly

To re-install the nozzle assembly, reverse the above steps.



DO NOT OPERATE THE ZIPSTOP WITHOUT THE NOZZLE ASSEMBLY PROPERLY INSTALLED.

Side Cover Replacement

The zipSTOP Brake Unit side covers are removable and simply snap into place on the device casing. Remove side covers by placing a flat head screwdriver under the edge of the cover and carefully levering it up. To replace, align the outer profile of the side cover with the profile of the casing and snap into place.



DO NOT OPERATE THE ZIPSTOP WITH SIDE COVERS REMOVED.

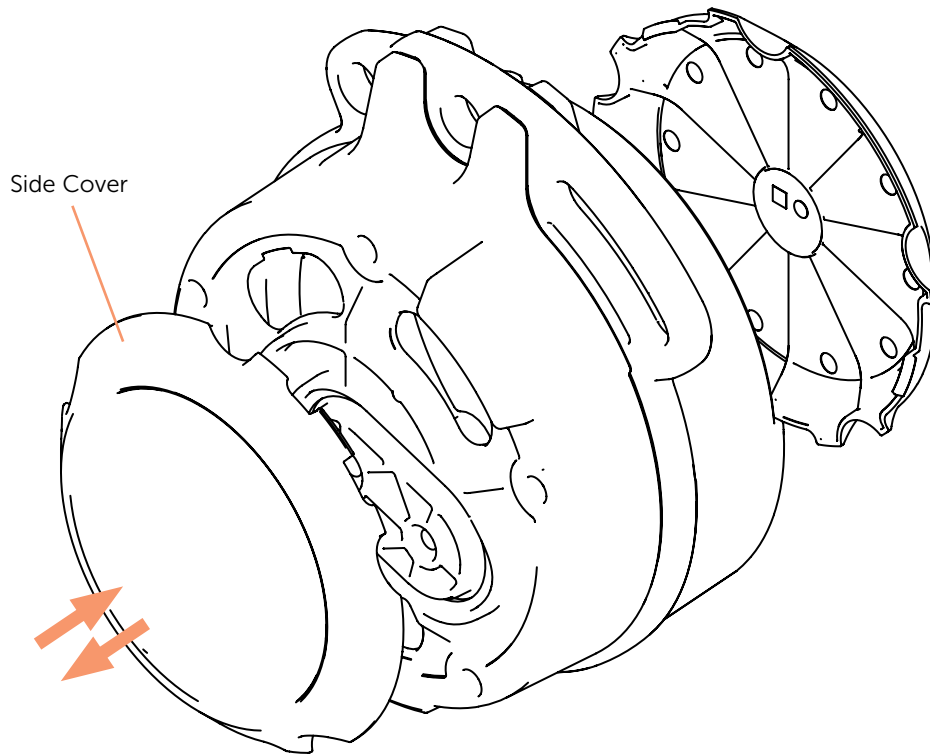

Side Cover Assembly

bumpSTOP Replacement

The bumpSTOP is a rubber bumper attached to the front of the brake trolley and requires periodic replacement when worn.

To replace the bumpSTOPS:

1. Remove the four (4) screws connecting the bumpSTOP and backing plate to the brake trolley.
2. One at a time, align the bumpSTOPS with the mating holes of the brake trolley and reinstall hardware.
3. Tighten bolts to 2.5 Nm [1.8 ft-lbs].

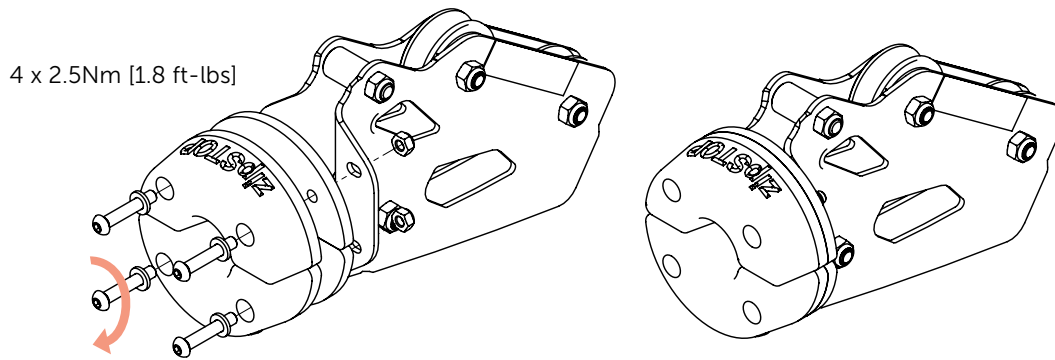

bumpSTOP Assembly



DAMAGE TO BUMPSTOPS CAN RESULT IN IMPROPER BRAKING AND DAMAGE TO RIDER TROLLEYS. REPLACE BUMPSTOPS WHEN WORN.

Long Term Storage

If the zipSTOP Brake Unit is to be placed into storage or left unused for longer than two weeks, ensure the unit is clean and dry and protected from the environment. Ensure the webbing assembly is fully retracted into the unit. Always store in a clean, cool and dry environment, preferably in the original packaging. Upon reinstallation of the device, carry out unmanned testing to recommission.

After exposure to water or damp conditions, thoroughly clean and dry the zipSTOP prior to storage. Ensure that the zipSTOP is not left with a wet webbing retracted inside the casing as this may result in corrosion of the unit and deterioration of the webbing. To dry the webbing / device, remove the side covers and fully extend the wet webbing assembly and allow to completely dry in a clean environment prior to storing the device. Ensure that debris does not enter the unit when side covers are removed. Reinstall the side covers prior to storing or using the unit.



DO NOT STORE THE ZIPSTOP, WEBBING ASSEMBLY OR ASSOCIATED COMPONENTS IN A WET CONDITION. STORAGE MUST BE IN A CLEAN, COOL, AND DRY ENVIRONMENT IN ACCORDANCE WITH THESE INSTRUCTIONS.



NEVER USE HEAT TO DRY THE WEBBING OR DEVICE.

IMPROPER OPERATION



THE FOLLOWING SCENARIOS ARE NOT ALLOWABLE, MAY CAUSE DEVICE DAMAGE, AND CREATE A DANGEROUS SCENARIO WHICH COULD RESULT IN EQUIPMENT DAMAGE, SERIOUS INJURY OR DEATH.

- Arriving faster than the device maximum may cause the following:
 - Separation or damage of the webbing and/or redirection rope.
 - Internal device damage to the zipSTOP which is not inspectable. This damage will cause sudden and repeated webbing damage during normal operation. If this occurs, the zipSTOP will need to be sent to an Authorized Servicing Agent for inspection and repair.
 - Exceeding the maximum braking distance resulting in undesired contact with the EAD.
 - Overextension of the webbing causing an abrupt stop and damage to the webbing/device.
 - Excessive braking force and rider swing up.
- Arriving with a higher weight than the device maximum may cause the following:
 - Separation or damage of the webbing and/or redirection rope.
 - Internal damage to the zipSTOP which is not inspectable. This damage may and manifest as problems with webbing retraction, extension.
- Using multiple zipSTOP devices simultaneously (in parallel) may cause the following:
 - Abrupt braking and rider swing up.
 - Damage to the webbing, redirection rope and/or zipSTOP internal components.
- Braking more than one rider at a time may cause the following:
 - Separation or damage of the webbing and/or redirection rope.
 - Abrupt braking and rider swing up.
 - Damage to the internal retraction spring resulting in failure to retract / reset.
 - Internal damage to the zipSTOP which is not inspectable.

MANUFACTURER'S DETAILS

ADDRESS

Head Rush Technologies
1699 Cherry Street, Suite C
Louisville, CO 80027

CONTACT DETAILS

+1-720-565-6885
www.headrushtech.com
info@headrushtech.com





REGISTER YOUR DEVICE

Get automatic updates on recertification and product information – visit [**headrushtech.com/register**](https://headrushtech.com/register)

ANNUAL RECERTIFICATION IS REQUIRED

Please keep the shipping box for your device. For instructions on annual recertification, visit [**headrushtech.com/annual-service**](https://headrushtech.com/annual-service)

+1-720-565-6885

www.headrushtech.com

info@headrushtech.com

Apr 2021